

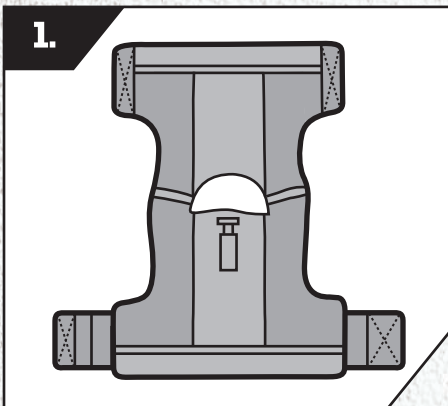

5.11® UNIFORM OUTER CARRIER SET-UP INSTRUCTIONS

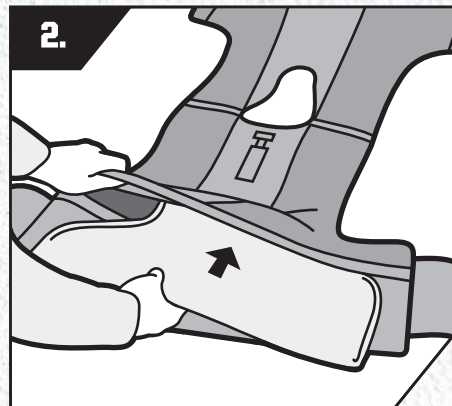

1. Completely unfold Uniform Outer Carrier and lay face down on flat surface



2. Insert back panel into back compartment

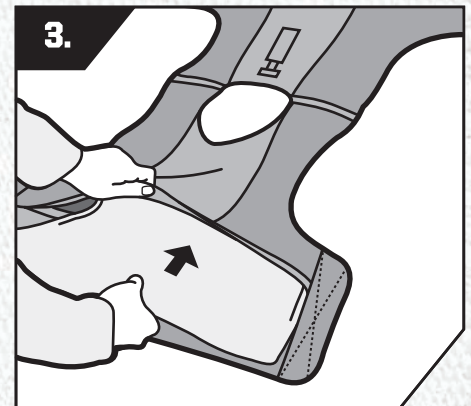

3. Insert front panel into front compartment

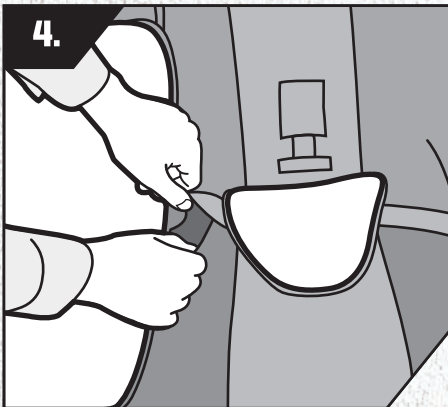

4. Link panels shoulder straps through openings at the carrier's shoulders

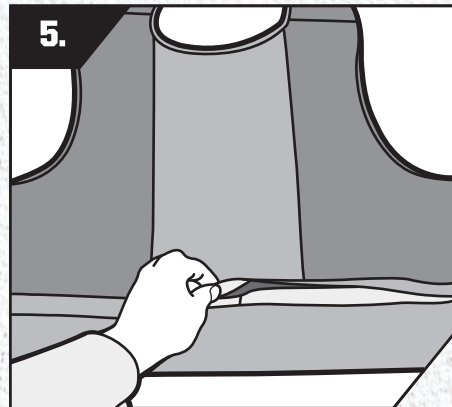

5. Connect hook and loop tabs to seal front and back panel compartments



6. Secure Uniform Outer Carrier onto shoulders

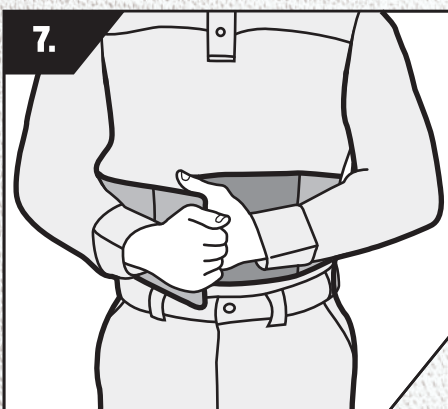

7. Attach elastic tabs over abdomen

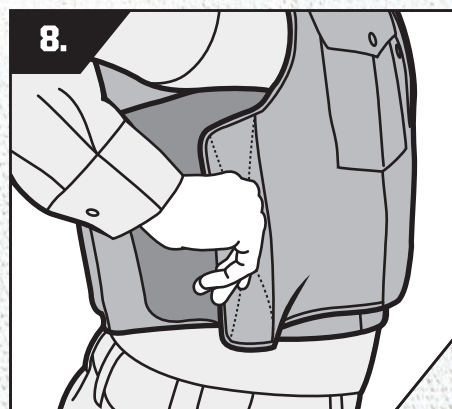

8. Join outer hook and loop panels

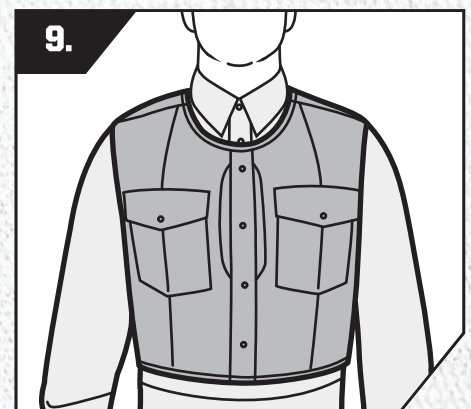

9. Secure carrier for a comfortable fit

WARNING: This outer carrier cover is designed solely for use as a cover for manufacturer-approved ballistic vest carriers and does **not** provide protection against ballistic threats, projectiles or sharp or pointed objects. Follow usage instructions provided by the manufacturer of your bullet-resistant garment. Failure to do so may result in injury or death.